

Gångbrygga 4m

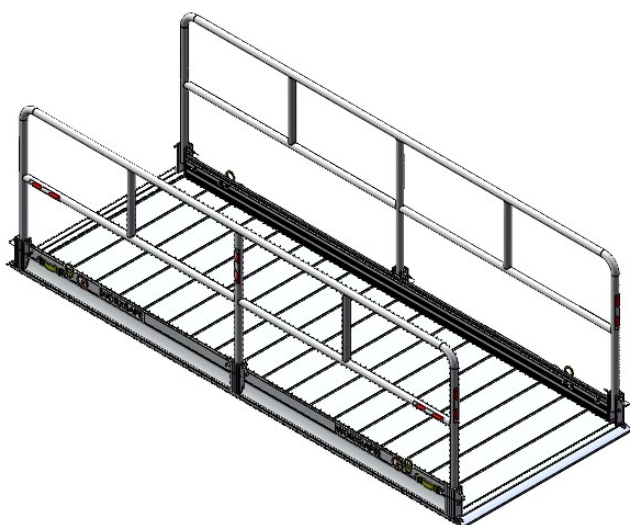

EN 13374-A

Boverkets regler
för handikappramper
BBR 3:122, 3:123, 8:2321



Aluminium



143

[mm]

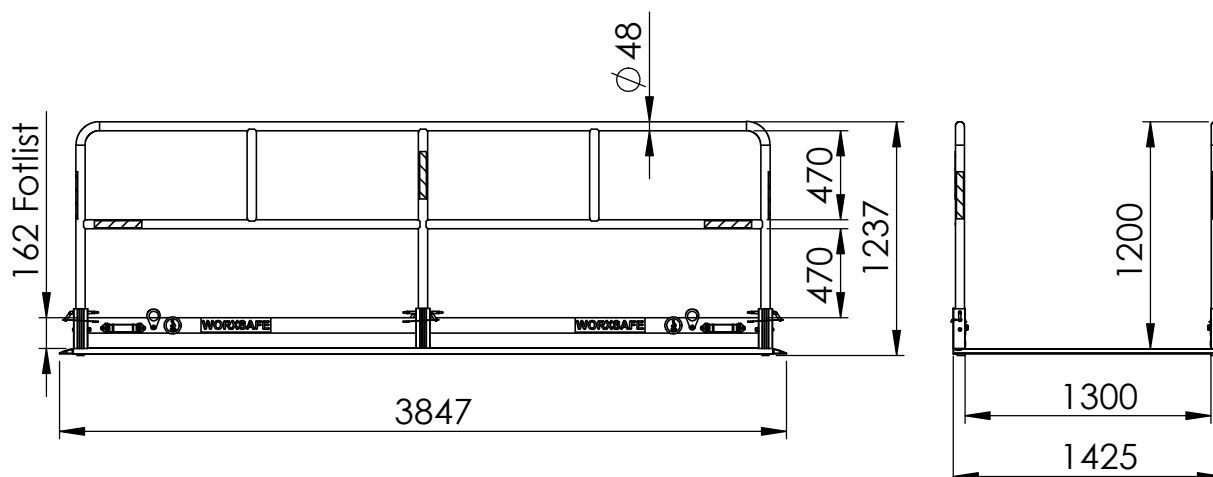

Montage

Max utbredd last: 1500 kg

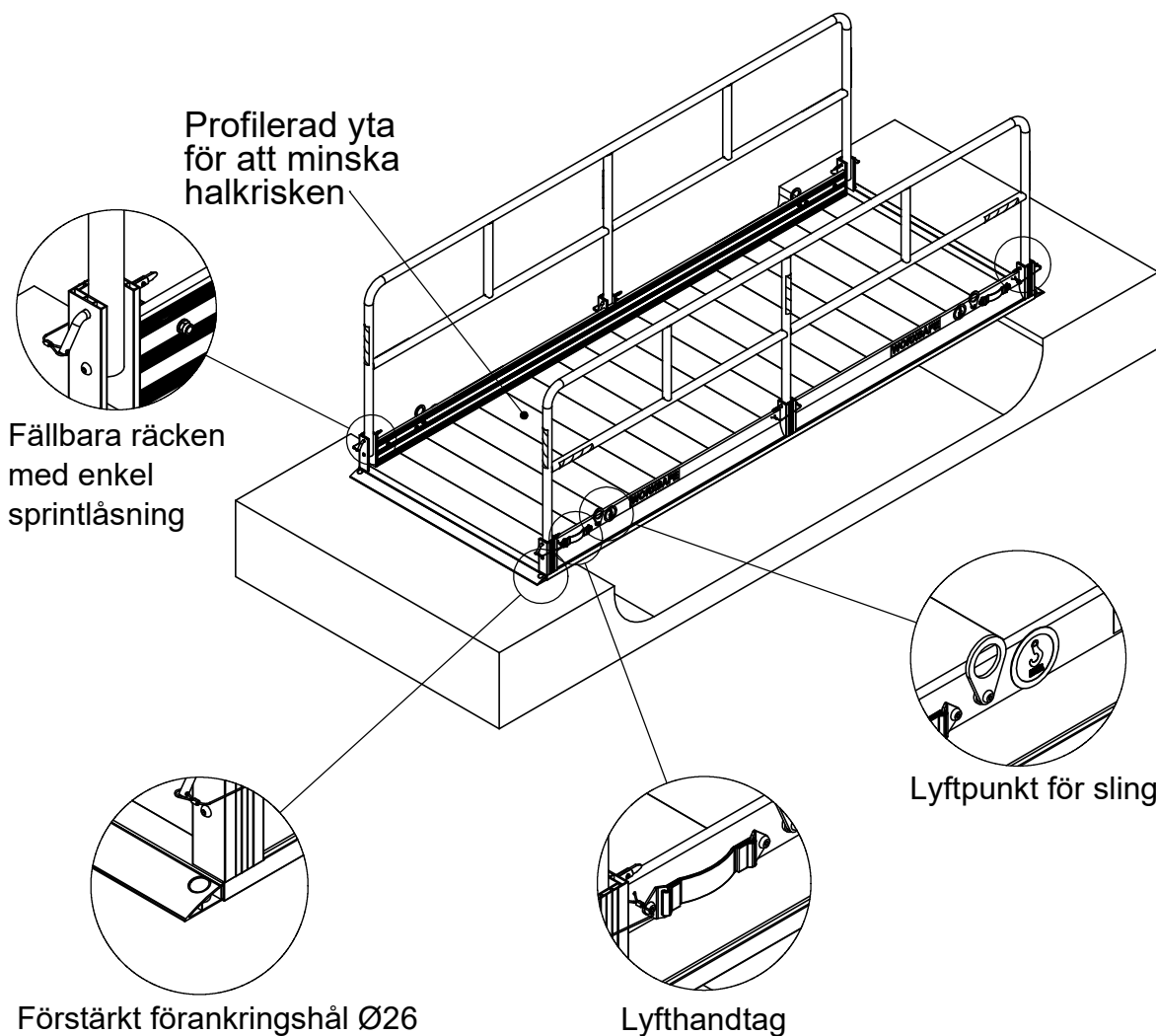
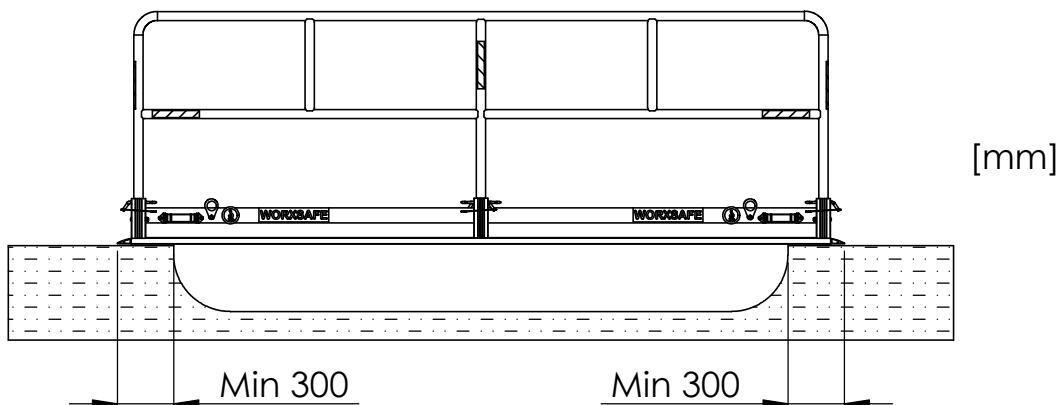



Transport/Packning

[mm]

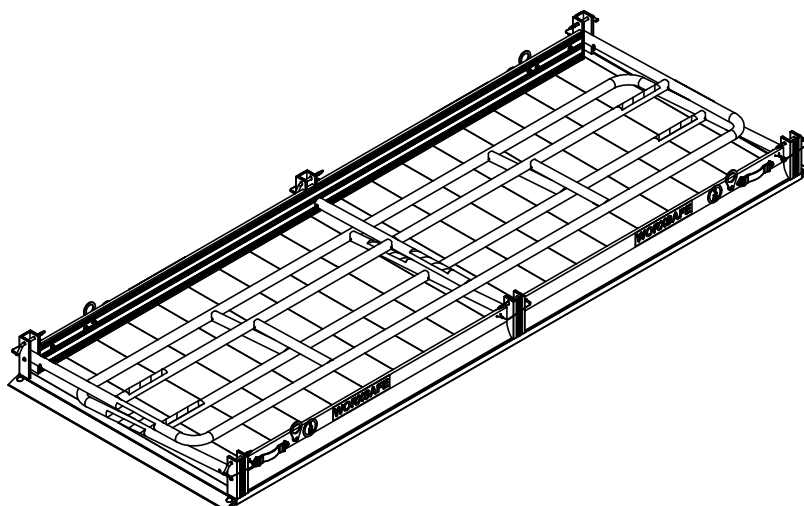
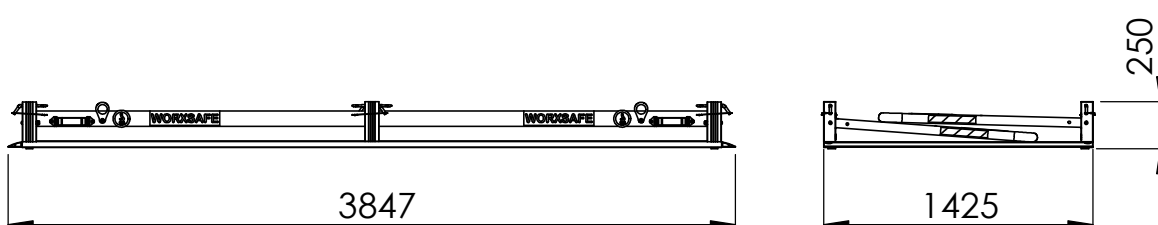



Reservdelar

831653

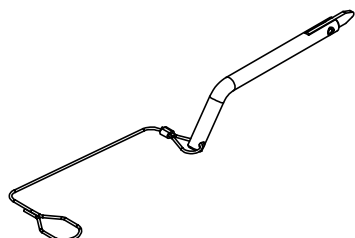

830738

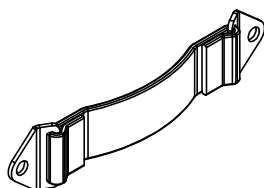

830858

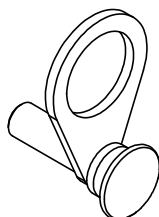

831627

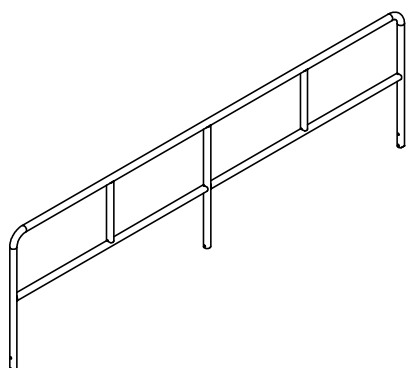

Produktfamilj

830743 Gångbrygga 2m

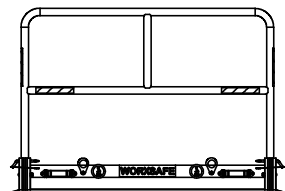

830804 Gångbrygga 3m

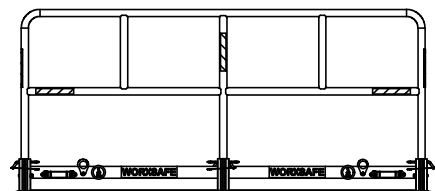

830639 Gångbrygga 4m

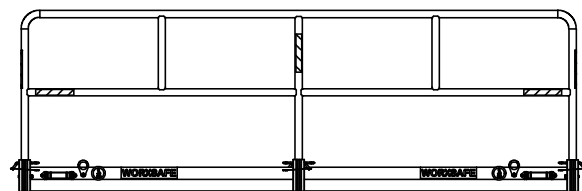

830744 Gångbrygga 6m

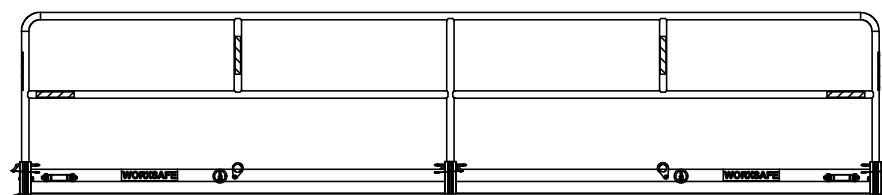















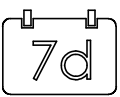

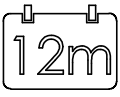
GENERELLT

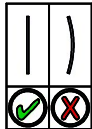
- Läs alltid igenom tillverkarens anvisningar för att säkerställa att produkten används på ett korrekt och säkert sätt.
- Vid oklarheter, kontakta tillverkaren eller aktuellt säljställe.
- Blanda aldrig produkter av olika fabrikat med varandra.
- Respektera alltid specificerade belastningsbegränsningar.

FÖRVARING

- Förvara i möjligaste mån produkterna i icke-korrosiv miljö.
- Tänk på att förvara produkterna på enligt tillverkaren avsett vis exempelvis vid stapling för att minimera risken för skador i samband med vältning eller liknande.

 Teknisk information	 Vikt	 Nm Momentdra skruvförband
 Inspektera	 Återvinning	 Lossa skruvförband
 Inspektionsintervall i dagar	 Korrekt	 Max tillåten vindhastighet
 Inspektionsintervall i månader	 Inkorrekt	 Kraft
 Kontrollera rakhet	 Se upp!	 Moment
 Kontrollera sprickbildning	 Drag åt skruvförband	 "Trä i"